

# OPERATION GUIDE

# 1F91-71

Multi-stage Electronic Digital  
Thermostat



**WHITE-RODGERS**

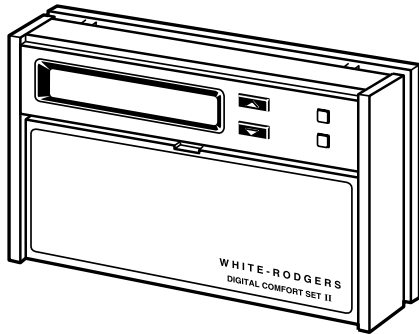

**Operator: Save this booklet for future use!**

---

## About Your New Thermostat . . .

---

Your new Digital COMFORT SET II Multi-stage Thermostat uses the technology of a solid-state microcomputer to provide precise time/temperature control. The COMFORT SET II Thermostat offers you the flexibility to design heating and cooling programs that fit your needs.

Please read this manual thoroughly before operating or programming your thermostat. If you have questions, you may write to our Technical Service Department at the address shown on the back cover of this booklet.

---

## In This Guide . . .

---

<b>YOUR NEW THERMOSTAT'S</b>		<b>PROGRAMMING YOUR</b>	
<b>FEATURES</b> .....	4	<b>THERMOSTAT</b> .....	17
<b>OPERATING YOUR THERMOSTAT</b> .....	5	<b>PLANNING FOR YOUR NEEDS</b>	
<b>PARTS OF THE THERMOSTAT</b>		<b>ENTERING YOUR PROGRAM</b>	
The Back Of the Thermostat Body		Set Current Time and Day	
The Display		Enter Heating Program	
The Thermostat Buttons		Enter Cooling Program	
<b>OPERATING FEATURES</b>		<b>CHECK YOUR PROGRAMMING</b>	
		<b>QUESTIONS AND ANSWERS</b> .....	28

**Operator: Save this  
booklet for future use!**

---

## YOUR NEW THERMOSTAT'S FEATURES

---

- Computed Energy Management Recovery (EMR)
- Automatic changeover (operator selectable)
- Five-day/two-day programming capability
- Simultaneous heat and cool program storage
- Preprogrammed temperature control
- Four separate time and temperature settings per 24-hour period
- Armchair programming capability
- Audio and visual prompting during programming
- Programmable blower control
- Two hour temperature override
- Manual program override (HOLD temperature)
- "Advance Program" button
- Backlit LCD displays continuous setpoint, time, and room temperature
- Adjustable cycle times
- 9 volt Energizer® alkaline battery backup
- Compressor short cycle protection
- Blower delay in the cooling cycle
- Up to three stages of heat and up to two stages of cool
- Temperature range 40° to 99°F
- °F/°C convertibility
- Compatible with Remote Sensor (optional)

---

## OPERATING YOUR THERMOSTAT

---

Before you begin programming your new thermostat, you should be familiar with its features and with the display and the location and operation of the thermostat buttons. The information in this section will help you become familiar with your thermostat so that you can easily program it.

Your thermostat consists of two parts: the **thermostat body** and the **subbase**.

### CAUTION

Use  to turn thermostat OFF before removing or attaching the thermostat body. Equipment damage and/or personal injury could occur.

The subbase is attached to the wall, but you can remove the thermostat body for easy programming. To remove the thermostat body from the subbase, grasp the thermostat body and gently pull it out from the bottom of the subbase, then pivot up. To attach the thermostat body, line up the four terminal pins on the upper section of the thermostat back with the matching connector on the subbase. Insert these, then gently pivot the thermostat body down to connect the nine pin connectors on the lower portion of the thermostat back. Gently push until the snap connectors engage. **DO NOT FORCE OR PRY THE THERMOSTAT**, as this may damage the unit.

## PARTS OF THE THERMOSTAT

### The Back of the Thermostat Body

Turn the thermostat body over. On the back are the 9 volt Energizer® alkaline battery and the option switches.

1. The 9 volt Energizer® alkaline battery provides power to the thermostat when the 24 VAC power is interrupted (for example, when you remove the thermostat from the wall for programming). A fresh battery will maintain the stored program for approximately one week. If power loss is long enough for the program to be lost, the thermostat will automatically maintain a factory preprogrammed heating temperature of 64°F and a cooling temperature of 82°F after power is restored. You must reprogram the thermostat if this happens.

If the word **BAT** is flashing in the display window, the battery is low and should be replaced with a fresh 9 volt Energizer® alkaline battery. The battery will provide power for all functions except the display

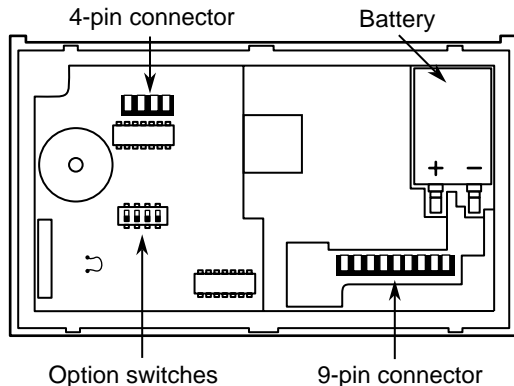



**BACK OF THERMOSTAT BODY**

light and audio prompting, which work only on 24 VAC power. If the word **BAT** is displayed continuously (non-flashing), the thermostat is not being supplied with 24 VAC power and is being powered by the battery alone.

2. You may adjust option switch #4 for automatic changeover from heating to cooling (see **OPERATING FEATURES**).

 **CAUTION**

Use  to turn thermostat **OFF** before removing thermostat from the wall to replace the battery.

Other than  and , the buttons are located behind the thermostat door. To open the door, use your fingernail in the indentation at the top center of the door. Pull the door out, then swing the door down on its hinges.

Following are brief descriptions of the display and the thermostat buttons.



### The Display

- ① Continuously displays system mode (**HEAT**, **OFF**, **COOL**, **AUTO**, **HOLD**). During programming, the program period is displayed (**MOR**, **DAY**, **EVE**, **NHT**).
- ② Alternately displays room temperature (**F** denotes degrees Fahrenheit and **C** denotes degrees Celsius) and time of day (**A** denotes AM time and **P** denotes PM time).
- ③ Displays the setpoint temperature.
- ④ **5 DAY** indicates that the displayed program is the weekday program. **2 DAY** indicates that the displayed program is the weekend program.
- ⑤ The word **BAT** flashes on the display when the 9 volt alkaline battery is weak and should be replaced.
- ⑥ **FAN ■** is displayed when the blower is operating continuously, regardless of heating or cooling system cycling. **FAN □** is displayed during automatic fan operation (when the blower cycles with the heating or cooling system).

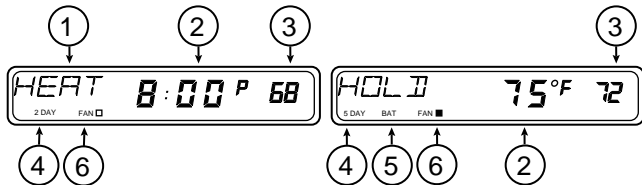
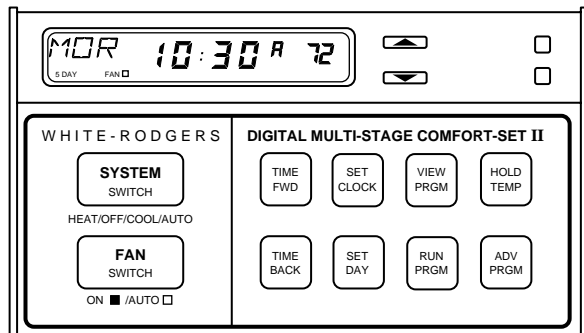



## The Thermostat Buttons

- ⑦ Sets the system mode (**HEAT**ing, **OFF**, **COOL**ing, or **AUTO**matic changeover [user selectable feature]).
- ⑧ Selects fan operation (see #6, above). This button is also used to program the fan to run continuously during a program period.
- ⑨ Runs display forward or backward through time, day, or anticipation settings during programming.
- ⑩ Used with  and  to set current time and day of the week.
- ⑪ Used during programming to set the day of the week. Also used with  to enter anticipation setting mode.
- ⑫ Used to initiate or review thermostat programming.
- ⑬ Used to start program operation after programming. Also used to return thermostat to program operation after being in **HOLD** mode.
- ⑭ Used to manually override programming to hold at a selected temperature (when **HOLD** is displayed).
- ⑮ Used to advance thermostat program to the next program period (for example, from the **MOR** program to the **DAY** program).
- ⑯ (Blue arrow) Lowers temperature setting (40°F or 4°C minimum).
- ⑰ (Red arrow) Raises temperature setting (99°F or 37°C maximum)

⑱ The red light is on when the 1st stage heating/cooling system is operating. The

yellow light is on when the 2nd or 3rd stage heating/cooling system is operating.

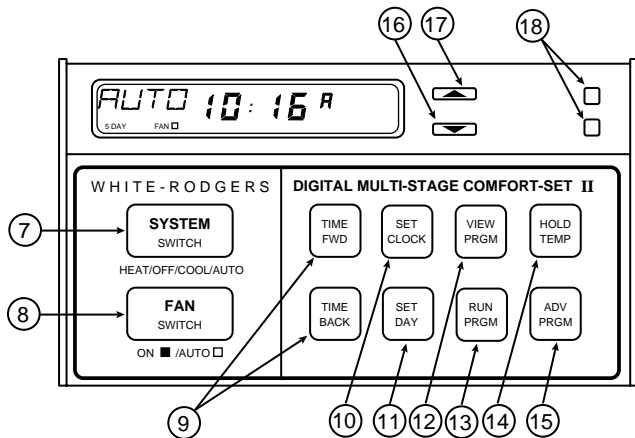

## OPERATING FEATURES

Now that you are familiar with the thermostat display and buttons, read the following information to learn about the many features of the thermostat.

- **COMPUTED ENERGY MANAGEMENT RECOVERY (EMR)** - The thermostat's microcomputer automatically calculates the time it will take to change the temperature to the next program setting. Then the thermostat will activate the heating or cooling system to change the temperature so that the desired temperature is reached at the beginning of the next program period. As an example of this feature, assume that you have programmed your thermostat to provide an overnight heating temperature of 62°F, and that during the next program

period, beginning at 6:00 AM, you have programmed a temperature of 70°F. The thermostat will automatically activate the heating system at about 5:00 AM, so that the programmed 70°F temperature is reached by about 6:00 AM.

- **AUTOMATIC CHANGEOVER** — You can set the thermostat to automatically switch the system from heating to cooling as needed. First, you must move option switch #4 (located on the back of the thermostat body) to the **ON** position, if it has not already been done. To do this, turn off 24 VAC power to the thermostat. Then, remove the thermostat body from the wall. Check the position of switch #4 (the last switch on the right). If it is **ON** (up), simply put the thermostat back on the wall and restore 24 VAC power. If the switch is **OFF** (down), use a

pencil or small screwdriver to move the switch to the **ON** position (see figure at right). Leave the battery out of the thermostat for at least **two minutes**, to allow the thermostat to reset itself. **DO NOT MOVE ANY OTHER OPTION SWITCH**, as it may affect thermostat operation. Replace the battery, put the thermostat back on the wall, and restore 24 VAC power. To set the thermostat for automatic changeover after pro-

gramming, press  to set the thermostat to **AUTO** (the setpoint display is **blank** in the **AUTO** mode). The system will now automatically switch between heating and cooling depending on the actual room temperature.



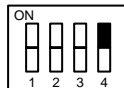



### Automatic Changeover (ON)

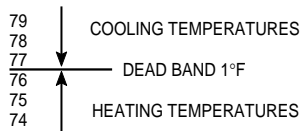



- Switch #1 set at installation (**DO NOT CHANGE**)
- Switch #2 set at installation (**DO NOT CHANGE**)
- Switch #3 set at installation (**DO NOT CHANGE**)
- Switch #4 **ON**

In the **AUTO** mode, the thermostat will not allow the temperature separation between the highest heat setting and the lowest cool setting to be less than 1°F. For example, if the highest heat setting is 76°F, the lowest cool setting cannot be below 77°F (see diagram below).



- **TWO HOUR TEMPERATURE OVERRIDE** — Press  or  until the display shows the temperature you want. The thermostat will override current programming and keep the room temperature at the selected temperature for two hours. After two hours, the thermostat will automatically revert to the program.
- **HOLD TEMPERATURE** — The thermostat can hold any temperature within its range for an indefinite period, without reverting to the program. Press . **HOLD** will be displayed. Then choose the desired hold temperature by pressing  or . The thermostat will hold the room temperature at the selected setting until you press  to start program operation again. This

feature is ideal for energy conservation when the building is unoccupied for an extended period of time.

- **“ADVANCE PROGRAM” BUTTON** — Press  to advance the thermostat program to the next period (such as from the **MOR** program period to the **DAY** program period). This change remains in effect until the next program period begins.
- **°F/°C CONVERTIBILITY** — Press  and  at the same time until the temperature display is in °C (Celsius). To display °F, repeat the process.
- **ADJUSTABLE HEATING AND COOLING CYCLE TIMES (ANTICIPATION)** — If the heating/cooling system is turning on and off

too often (short cycles) or not often enough (long cycles), you may want to adjust the anticipation setting.





**⚠ CAUTION**

**A cooling anticipation setting of less than 10 may cause decreased compressor life.**

To adjust anticipation, press **SET CLOCK** and **SET DAY** at the same time. The display will show **HEAT 8** (this is the factory preprogrammed heating anticipation setting). You may select any anticipation setting from 4 to 40. Whenever adjusting anticipation, increase or decrease the displayed number by only one or two digits, then let the system run for a while to see if the adjustment is sufficient.

If the heat cycles are too short, press **TIME FWD** to increase the cycle time. If the heat cycles are too long, press **TIME BACK** to decrease the cycle time. To set cooling anticipation, press **SET CLOCK** and **SET DAY** at the same time again. The display will show **COOL 14** (factory preprogrammed cooling anticipation). Use the **TIME FWD** and **TIME BACK** buttons to adjust anticipation. Press **RUN PRGM** to return to your program.

- **LOW BATTERY INDICATOR** — The word **BAT** will flash on the display if the 9 volt alkaline battery is low and should be replaced.

- **AUDIO PROMPTING** — Each time you press a button, the thermostat will beep.
- **BACKLIT DISPLAY** — When you press any button on the thermostat, the display is lit for approximately eight seconds (this feature works only when the thermostat is attached to the wall and 24 VAC power is present to the thermostat).
- **COMPRESSOR SHORT CYCLE PROTECTION** — To protect your compressor from potential damage due to rapid cycling, this thermostat has a built-in delay of 5 minutes between cooling cycles. The blower will operate during a time delay, but the air circulated will not be cooled. The following may cause a time delay in **COOL**:
  - a) Return of power after a power outage.
  - b) Pressing  to change operating modes.
  - c) Pressing  or  to create a call for **COOL** too soon after a previous call.
- **SYSTEM INDICATOR LIGHTS** — The red indicator light comes on whenever the first stage heating or cooling system is operating. The yellow indicator light comes on when the second or third stages of heating or cooling are operating.
- **PROGRAMMABLE BLOWER CONTROL** — You may program the fan blower to run continuously during any given program period, regardless of the cycling of the heating or cooling system. During programming, after entering the time and temperature for the time period, press  until



**FAN** ■ is displayed. To override constant fan, press  until **FAN** □ is displayed.

---

## PROGRAMMING YOUR THERMOSTAT

---

Now you are ready to program your thermostat. This section will help you plan and program your thermostat to meet your needs.

For maximum comfort and efficiency, keep the following guidelines in mind when planning your program.

- When heating (cooling) your building, program the temperatures to be cooler (warmer) when the building is vacant or during periods of low activity.
- During early morning hours, the need for cooling is usually minimal.

### PLANNING FOR YOUR NEEDS

This thermostat will store separate heating and cooling programs for five-day (weekday) and two-day (weekend) operation. Usually, the five-day program is set to run Monday through Friday, and the two-day program is set to run Saturday and Sunday. However, you may choose any five consecutive days to be your weekday program days (such as Sunday through Thursday; in this case, your weekend program would run on Friday and Saturday).

First, you should answer the following questions to help you decide what your needs are. If you are using the thermostat for a commercial application (a store, office building, etc.), answer questions 1 through 4. If you are using the thermostat in your home, answer questions 5 through 8. Keep in mind that you should plan for both weekday and weekend programs.

#### **FOR COMMERCIAL APPLICATIONS:**

- 1a. What time does the first person arrive at the building in the morning?
- b. What temperature should the building be at this time? (heating? cooling?) These will be your **MOR** (morning) temperature settings.
- 2a. What time do the building occupants reach a maximum activity level (using lights, equipment, meeting rooms, etc.)?

- b. What temperature should the building be at this time? These will be your **DAY** temperature settings.
- 3a. What time do the building occupants reach a minimum activity level (limited personnel in building)? These will be your **EVE** (evening) temperature settings.
  - b. What temperature should the building be at this time?
- 4a. What time does the building become vacant?
  - b. What temperature should the building be at this time? These will be your **NHT** (night) temperature settings.

#### **IN YOUR HOME:**

- 5a. What time does the first person get up in the morning?

- b. What temperature should the house be at this time? These will be your **MOR** (morning) temperature settings.
- 6a. What time does the last person leave the house in the morning?
  - b. What temperature should the house be at this time? These will be your **DAY** temperature settings.
- 7a. What time does the first person arrive home in the evening?
  - b. What temperature should the house be at this time? These will be your **EVE** (evening) temperature settings.
- 8a. What time does the last person go to bed at night?
  - b. What temperature should the house be at this time? These will be your **NHT** (night) temperature settings.

Now look at the factory preprogrammed times and temperatures shown at the top of the next page. If this program will suit your needs, simply press  to begin running the factory preset program.

If you want to change the preprogrammed times and temperatures, do the following.

## NOTE

To operate properly in the **AUTO** mode, there must be a **minimum 1°F separation** between the highest heat temperature and the lowest cool temperature (see diagram below).

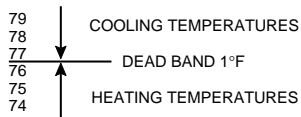

## FACTORY PREPROGRAMMING

Heating Program for ALL days of the Week:

PERIOD	TIME	TEMP
MOR	5:00 AM	70
DAY	9:00 AM	70
EVE	4:00 PM	70
NHT	10:00 PM	64

Cooling Program for ALL Days of the Week:

PERIOD	TIME	TEMP
MOR	5:00 AM	78
DAY	9:00 AM	82
EVE	4:00 PM	78
NHT	10:00 PM	78

---

Determine the time periods and heating and cooling temperatures for your weekday program. You must program 4 periods for each day (**MOR**, **DAY**, **EVE**, and **NHT**). However, you may use the same heating and cooling temperatures for consecutive time periods. You can choose start times, heating temperatures, and cooling temperatures independently for both weekday and weekend programs (for example, you may select 5:00 AM and 70° as the

weekday **MOR** heating start time and temperature, and choose 7:00 AM and 76° as the weekday **MOR** cooling start time and temperature). Use the following table to plan your program time periods, and the temperatures you want during each period. You may also want to look at the sample program table to get an idea of how the thermostat can be programmed.

## Heating/Cooling Schedule Plan

	WEEKDAY (5 DAY)		WEEKEND (2 DAY)	
	Start Time	Temperature	Start Time	Temperature
<b>MOR HEAT</b>				
<b>DAY HEAT</b>				
<b>EVE HEAT</b>				
<b>NHT HEAT</b>				
<b>MOR COOL</b>				
<b>DAY COOL</b>				
<b>EVE COOL</b>				
<b>NHT COOL</b>				

**SAMPLE  
Heating/Cooling Schedule Plan**

	<b>WEEKDAY (5 DAY)</b>		<b>WEEKEND (2 DAY)</b>	
	Start Time	Temperature	Start Time	Temperature
<b>MOR HEAT</b>	5:30 AM	68°	7:30 AM	68°
<b>DAY HEAT</b>	8:00 AM	66°	2:00 PM	70°
<b>EVE HEAT</b>	4:30 PM	70°	6:00 PM	70°
<b>NHT HEAT</b>	11:00 PM	66°	12:00 AM	66°
<b>MOR COOL</b>	8:00 AM	76°	8:00 AM	76°
<b>DAY COOL</b>	12:00 PM	78°	2:00 PM	74°
<b>EVE COOL</b>	4:30 PM	74°	6:00 PM	74°
<b>NHT COOL</b>	11:00 PM	78°	12:00 AM	78°

## ENTERING YOUR PROGRAM

Follow these steps to enter the heating and cooling programs you have selected.

### NOTE

We recommend that you remove the thermostat from the wall for programming (especially for entering cooling programming). A fresh 9 volt Energizer® alkaline battery must be installed to perform off-wall programming. **BE SURE SYSTEM SWITCH IS SET TO OFF POSITION BEFORE REATTACHING THERMOSTAT TO SUBBASE!**



### NOTE

You cannot program the thermostat with the **SYSTEM SWITCH** in the **AUTO** position.

## Set Current Time and Day



1. Press  once. The display will show minutes only.



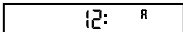

EXAMPLE: 

2. Press and hold either  or  until you reach the correct minutes.

3. Press  once. The display window will show the hour only.



EXAMPLE: 



4. Press and hold either  or  until you reach the correct hour and AM/PM designation (**AM** begins at midnight; **PM** begins at noon).

5. Press  once. The display will show the day of the week as an abbreviation (**MO** for Monday, **TU** for Tuesday, etc.).
6. Press and hold either  or  until you reach the current day of the week.
7. Press  once. The display will show the correct time and room temperature alternately.

### Enter Heating Program

During programming, if you don't press any buttons for 5 minutes, the thermostat will enter the **HOLD** mode and will maintain a constant temperature. The display will revert to the alternating time/temperature display. To resume





programming after this happens, press  until you are at the point where you stopped programming. Then you may continue to enter your programs normally. If you want to stop programming at any time, simply press  to resume program operation.



1. Press  until **HEAT** is displayed.
2. Press  once. **5 DAY** (indicating week-day program), and **MOR**, representing the **morning** heating period, will appear in the display. Also displayed are the currently programmed start time for the **MOR** period and the currently programmed temperature.

EXAMPLE: 



This display window shows that for the weekday **MOR** period, the start time is 5:00 AM, and 70° is the programmed temperature (this example reflects factory preprogramming).

- To change the displayed start time to your selected start time for weekday **MOR** heat program, press  or  until your selected time appears. The time will change in 15 minute increments.
- Press  or  until you reach your selected weekday **MOR** heating temperature.
- If you want the fan to run continuously during this period, press  until **FAN ■** is displayed.

- Press . The currently programmed start time and heating temperature for weekday **DAY** will be displayed.
- Repeat steps 3 through 5 to select the start time and heating temperature for the weekday **DAY** program.
- Repeat steps 3 through 7 for the weekday **EVE** and **NHT** heating programs.
- After entering your weekday heating program, repeat steps 1 through 8 for your weekend programming (keep in mind that for weekend programming, the display should be changed from **5 DAY** to **2 DAY**).
- When you have completed entering your heating program, press .

## Enter Cooling Program



### CAUTION



If outside temperature is below 50°F, we recommend that you remove the thermostat from the wall before proceeding with the following steps to program cooling temperatures. Personal injury or property damage may occur due to air conditioner compressor slugging. A fresh 9 volt Energizer® alkaline battery must be installed to perform off-wall programming. Programming away from the wall should prevent accidental compressor operation. **BE SURE SYSTEM SWITCH IS SET TO OFF POSITION BEFORE REATTACHING THE THERMOSTAT TO THE SUBBASE!**

1. Press  until **COOL** appears.
2. Enter your cooling program by following the procedure for entering your heating program.



## CHECK YOUR PROGRAMMING

Follow these steps to check your thermostat programming one final time before beginning thermostat operation.

1. Press  until **HEAT** is displayed.
2. Press and hold  to view the heating period times and temperatures in sequence for weekday **MOR**, **DAY**, **EVE**, and **NHT**, then for weekend **MOR**, **DAY**, **EVE**, and **NHT**.

3. Press  .
4. Press  until **COOL** is displayed.
5. Repeat step 2 to check cooling temperatures.
6. Press  to begin program operation.

**YOUR THERMOSTAT IS NOW COMPLETELY PROGRAMMED AND READY TO AUTOMATICALLY PROVIDE MAXIMUM COMFORT AND EFFICIENCY!**





Press  until **OFF** is displayed. Reattach thermostat to subbase. Then press  to select the operation mode you want (**HEAT, COOL, AUTO**). Press  until **FAN**  is displayed (automatic cycling).

---

## QUESTIONS AND ANSWERS

---

1. **How can I permanently change a part of my program?**

Press  until you reach the time/temperature schedule you want. Then press  or  and  and  to change the program. See **PROGRAMMING YOUR THERMOSTAT**.

2. **How can I have no change in temperature from one time period to another?**

Simply select the same temperature for each consecutive time period. For example, you may select the same weekday **EVE** cooling temperature as you did for weekday

**DAY**, which means the temperature will not change when the **EVE** period begins. See **PROGRAMMING YOUR THERMOSTAT**.

3. **How can I finish my programming if the display has already changed to time/temperature?**

During programming, if no buttons are pressed for five minutes, the thermostat will enter the **HOLD** mode and maintain a constant temperature. The display will change to the time/temperature mode. To resume programming, press  until you return to the point where you stopped programming. Then you may continue to program the thermostat normally. If you want to stop

programming at this point, press  to start the normal program function. See **PROGRAMMING YOUR THERMOSTAT**.

**4. What happens if the electricity goes off or is manually shut off?**

If you have not installed a 9 volt alkaline battery, the display will go blank and the program will be lost in approximately one minute. When electricity is restored, the thermostat will maintain a heating temperature of 64°F and a cooling temperature of 82°F until you reenter your program. Set-point temperature will not be displayed.

If a fresh 9 volt Energizer® alkaline battery is installed, the program will be maintained for about one week with no 24 VAC power present to the thermostat. See **OPERATING YOUR THERMOSTAT**.

**5. Why can't I program the thermostat in the AUTO mode?**



The thermostat can only be programmed in the **HEAT** and **COOL** modes. See **PROGRAMMING YOUR THERMOSTAT**.

**6. What can cause the thermostat display to freeze or go blank?**

A completely blank display may indicate that power has been lost to the thermostat and the backup battery is also dead. However, if there is power to the thermostat and the display is blank or frozen, static discharge is probably the cause.

During periods of low humidity (especially during cold weather), you may feel or see a spark discharge when you touch the thermostat. This may cause the program to be lost or the thermostat to display incorrectly. To correct this, remove the thermostat from

the wall and disconnect the battery. Wait about one minute, then reconnect the battery. The thermostat will revert to the factory preset program until you reprogram the thermostat. If you don't want to reprogram

the thermostat immediately, press  until **OFF** is displayed and replace the thermostat on the wall. Then press  to begin the factory preset program. Or you may reprogram the thermostat, then replace it on the wall.

To prevent further static discharge problems, touch another object to release static build-up before touching the thermostat. See **OPERATING YOUR THERMOSTAT**.

## 7. Why won't the setpoint temperature go to the temperature I want?

In the **AUTO** mode, the highest heating setpoint temperature you select must be at least 1°F lower than the lowest cooling setpoint temperature you select (for example, if 70°F is your lowest selected cooling temperature, you cannot select a heating temperature any higher than 69°F). If such a conflict exists, you must set the lowest cooling temperature higher in order to set the heating temperature higher. To set a lower cooling temperature, you must select a lower heating temperature. See **PROGRAMMING YOUR THERMOSTAT**.



8. **Why doesn't the display light come on when I press a button? Why don't I hear a beep when I press a button?**

The display light and audio prompting (beep) only work when the thermostat is on the wall and 24 VAC power is present to the thermostat. These features will not work on battery power alone. See **OPERATING YOUR THERMOSTAT**.

9. **The display is flashing BAT. What does this mean?**

The 9 volt battery installed in the thermostat is low and should be replaced with a fresh 9 volt Energizer® alkaline battery. See **OPERATING YOUR THERMOSTAT**.

10. **Why won't the system turn on, even though the thermostat display is functioning normally?**

Either the compressor lockout feature is in operation or the thermostat is not currently calling for heat or cool. Wait about 5 minutes for the compressor lockout to expire. If the system is still not running, **read the following cautionary statement on the next page**. Then, **if conditions permit**, use the  or  buttons to move the temperature above or below the setpoint temperature. See **OPERATING YOUR THERMOSTAT**.

**! CAUTION**

If the outside temperature is below 50°F, **DO NOT** use the  button to move the temperature below the setpoint temperature. Property damage may result due to compressor slugging.

**11. Why doesn't the temperature change at the time I programmed?**

There may be a number of causes for this situation. The following are primary reasons.

- The **EMR** function is operating. The **EMR** function will bring the system on automatically to bring the temperature to the selected level by the beginning of the next program period. See **OPERATING YOUR THERMOSTAT**.

- You have programmed the incorrect day or time. Check your programming (be sure that the times you programmed are correct AM or PM times). See **PROGRAMMING YOUR THERMOSTAT**.
- The thermostat is in the **HOLD** mode. Press  to start program operation. See **OPERATING YOUR THERMOSTAT**.
- The compressor lockout feature is operating; wait about 5 minutes for system to begin running. See **OPERATING YOUR THERMOSTAT**.





**12. Why does the blower fan keep running after the system has turned off?**

- You have programmed the fan to run continuously during this period. See **PROGRAMMING YOUR THERMOSTAT**.
- The blower delay feature is operating. This energy saving feature continues to blow conditioned air through the ducts after the system has turned off, rather than letting the air dissipate.

**13. Why is the system turning on and off so frequently (seldom)?**

The anticipation setting is too low (high). To change anticipation settings, see **OPERATING YOUR THERMOSTAT**.

**14. Between heating and cooling seasons, I want to turn my system off. Can I do this without affecting my thermostat programming?**



Any time you wish to turn your system off, simply press  until the display shows **OFF**. This will not affect your thermostat's programming in any way. To turn the system back on, press  until **HEAT**, **COOL**, etc. is displayed. The system will automatically begin operating according to the current thermostat program, unless the thermostat is in the **HOLD** mode. See **OPERATING YOUR THERMOSTAT**.

**15. I live in an area where daylight savings time is observed. How do I change the thermostat clock twice a year without affecting thermostat programming?**

To change the clock, follow the instructions for setting current time and day (see **ENTERING YOUR PROGRAM**). Thermostat programming is not affected when you change the clock.

**16. Do I have to reprogram my thermostat after I change the battery?**

When the thermostat is on the wall and the system has power, the thermostat is being powered by a 24 VAC source. If power is lost, or if the thermostat is removed from the wall, the program will be retained for approximately **one minute** if there is no battery installed or if the installed battery is dead. If you are changing the battery after seeing a flashing **BAT** on the display, the installed battery may be dead. If you remove the old battery and install a fresh one within one minute, you should not lose your thermostat programming. After installing a new battery, follow the procedures in **CHECK YOUR PROGRAMMING** to determine whether your programming was maintained.

If the thermostat maintains programming, press  until **OFF** is displayed, put the thermostat back on the wall, press  again to select the operating mode you want, then press  to start program operation. If the program is lost, reprogram the thermostat. See **PROGRAMMING YOUR THERMOSTAT**.

If you need further information on programming or operation, you may write to our Technical Service Department at the address shown below.



**WHITE-RODGERS DIVISION**  
EMERSON ELECTRIC CO.  
9797 REAVIS ROAD  
ST. LOUIS, MISSOURI 63123-5398

**Part No. 37-4739C**  
Replaces 37-4739B  
9606